



Description & Features:

- Spring loaded allowing TST to stay open when tridicator is installed. Once tridicator is removed thermowell closes preventing media from exiting the system
- Minimizes system downtime with quick instrument replacement
- CRN registered
- Up to 250 psi pressure rating (matching TTD Tridicator)
- 5 year warranty

Applications:

- Boilers and hydronic heating systems

Specifications

Material	Brass
Tridicator Connection	1/4" or 1/2" NPTM standard
Warning	 WARNING: This product can expose you to chemicals including lead, which is known to the State of California to cause cancer and birth defects or other reproductive harm. For more information go to www.P65Warnings.ca.gov .

Order Codes (products in bold are normally stock in North America)

Stem Length	Maximum Extension (X)	Instrument & Pipe NPT Connection	Code
1.92" (48.8mm)	1.3" (33.8mm)	1/4"	TST025
2.65" (67.3mm)	1.6" (41.5mm)	1/2"	TST050

1/4" TST025

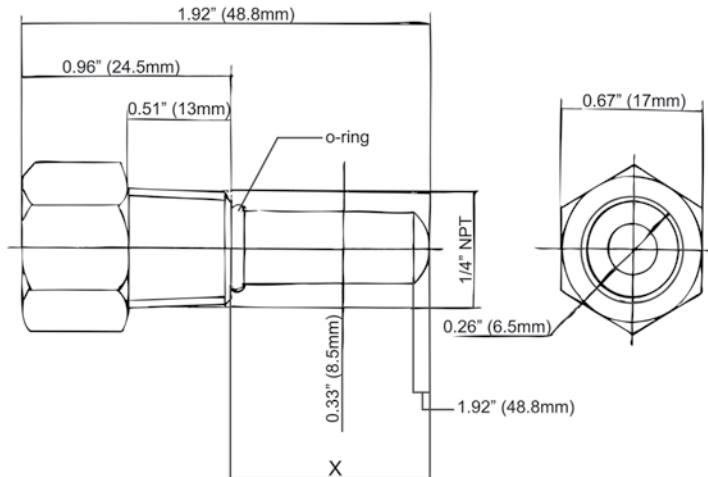

1/2" TST050

